

Secure Safe Trend II

for protection of documents, cash and valuables

Looking for a combined safe for storing documents together with cash and valuables in a secure way? Look no further.

The Secure Safe Trend II is designed to protect any valuable goods against burglary. Furthermore the Trend II range is provided with insulation material which offers fire protection. Items recommended for storage include cash, jewellery, passports, contracts, photographs, and digital cameras to name a few. For at home or in any business environment, the Secure Safe Trend II range offers effective security at an affordable price.

Models

The Secure Safe Trend II is available in six models, all designed to hold cash and valuables and to store documents. For storing binders we recommend model 44 in which the binders can be stored vertically.

Construction

The Trend II range has a double wall construction, 3 mm external and 2 mm internal and an 8 mm solid steel door. Filled with insulation material the Trend II range offers in addition fire protection in accordance with DIN 4102. Increased security is achieved by hardened steel plates which protect the lock, bolt-work and bolts against drilling. The durable bolt-work has 2 or 4 bolts, which are chrome plated and have a diameter of 25 mm.

Locking

The safes are offered with a double bitted key lock or electronic PIN-code lock (6 digits) with a LCD-display. The electronic lock version is additionally equipped with a mechanical override in case of emergency opening is necessary.

Additional features

The safes can be fixed to the floor or wall using the included fixing kit. In addition the safes are supplied with a removable shelf as standard (except model 18).

Design

The Trend range has modern styling and will complement any user environment. The safes are in two-tone colour powder coated finish; light grey and dark grey.



Secure Safe Trend II

Models

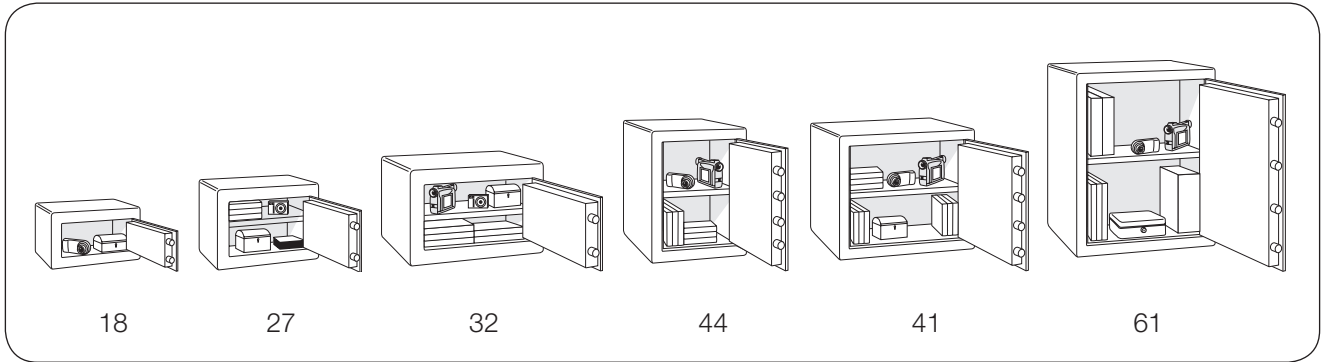

SLGB.1004.R5

Product data

Key lock

Model	Article No.	External dimensions (mm)			Internal dimensions (mm)			Volume (litres)	Weight (kg)	Shelf (qty)	Bolts (qty)
		Height	Width	Depth	Height	Width	Depth				
TII-18K	SL02500	180	310	205	100	230	110	3	16	–	2
TII-27K	SL02501	270	350	345	190	270	250	13	28	1	2
TII-32K	SL02502	320	440	395	240	360	300	26	45	1	2
TII-44K	SL02503	440	320	395	360	240	300	26	45	1	4
TII-41K	SL02504	410	460	395	330	380	300	38	54	1	4
TII-61K	SL02505	610	460	395	530	380	300	60	73	1	4

Electronic lock

Model	Article No.	External dimensions (mm)			Internal dimensions (mm)			Volume (litres)	Weight (kg)	Shelf (qty)	Bolts (qty)
		Height	Width	Depth	Height	Width	Depth				
TII-27E	SL02507	270	350	345	190	270	250	13	28	1	2
TII-32E	SL02508	320	440	395	240	360	300	26	45	1	2
TII-44E	SL02509	440	320	395	360	240	300	26	45	1	4
TII-41E	SL02510	410	460	395	330	380	300	38	54	1	4
TII-61E	SL02511	610	460	395	530	380	300	60	73	1	4

SecureLine policy is one of constant improvement. The above specification may therefore be altered without prior notification.

www.Secure-Line.net

Authorised dealer: